

Vista Patioslide

Vista Patioslide is our latest bottom rolling sliding door system especially for patio doors. With height adjustable bottom rollers, rattleproof top guidance, interlocks and locking system this kit offers a one stop shop for the customer.

2 Roller capacities are available - 100kg or 200kg. Each roller housing has 2 wheels (100kg) or 4 wheels (200kg) and has height adjustment of +/- 3mm.

The 6 point locking system comes complete with a single piece Keep and allows for a male/female closing jamb arrangement for maximum weather proofing. A 80mm euro cylinder is also supplied.

Handles can be purchased in multiple finishes. Satin Chrome and Polished Chrome are standard stock items with the remainder having a lead time of 7-10 days.

Components are sold separately or available in kits.

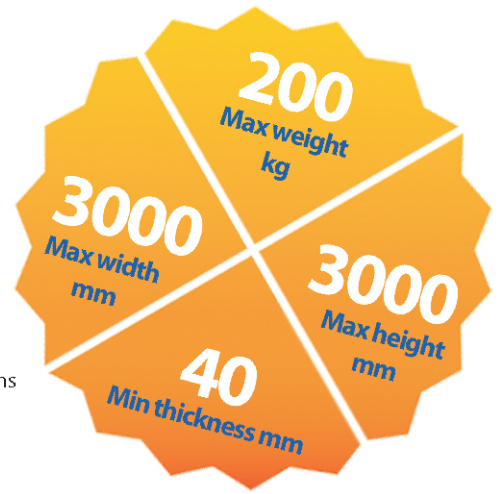

Locking Jamb Detail

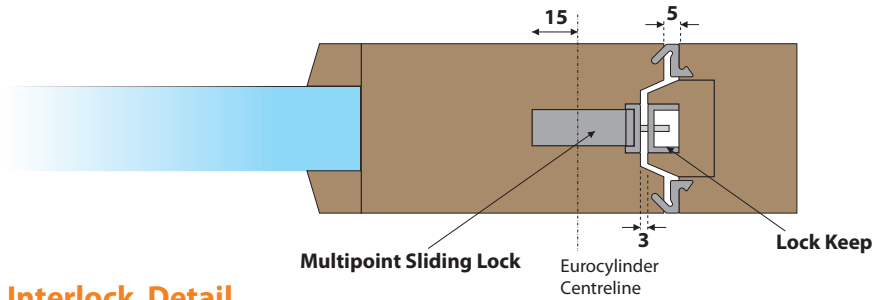

Standard Section Detail

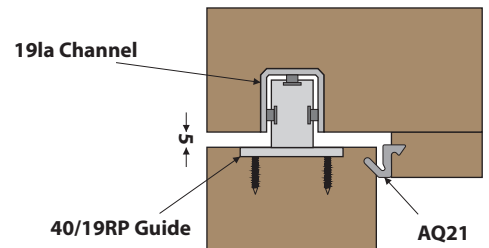

Interlock Detail

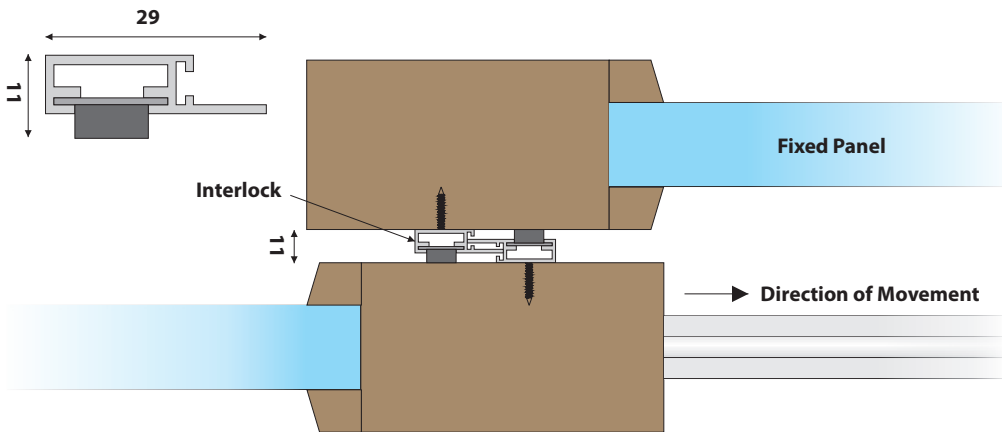

Track Profiles

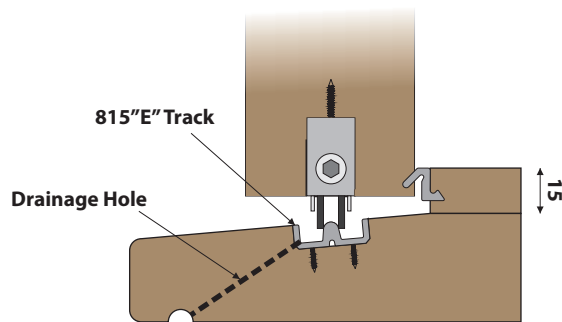
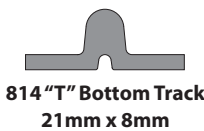
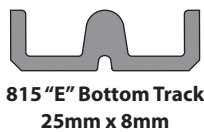
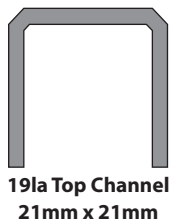

Alternative Recessed Track Detail

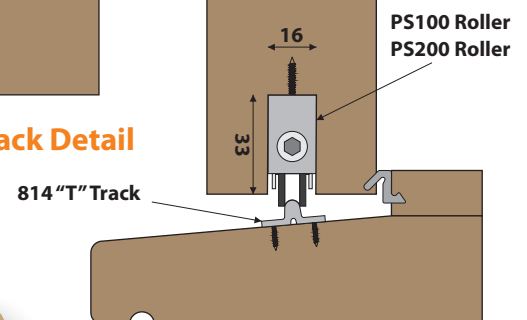

Handle Colour Options

White 9016 Black 9005 Satin Chrome Smokey Chrome Polished Chrome PVD Gold



Unit 8 Dolphin Point
Dolphin Way, Purfleet,
Essex. RM19 1NR
Tel: 01708 891515
www.barrier-components.co.uk
sales@barrier-components.co.uk

