



# Sliding Door Hardware

[www.barrier-components.co.uk](http://www.barrier-components.co.uk)  
01708 891 515





# Cupboard & Wardrobe Systems



## Linear

Linear rail system comprises of 2 tracks and 4 guides which can be mounted and used both horizontally or vertically. Ideal for small cabinets or wall mounted sliding panels such as blackboards and projector screens.



## Hatch T

Bottom rolling system for smaller panels. Ideal for small cupboards and serving hatches. Nylon wheels & guides with aluminium tracks ensure a smooth operation with minimal friction or noise.

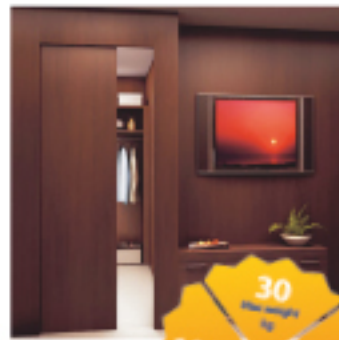

## Flush

Specialist high quality top hung system that allows a sliding door to close into an opening creating a flush finish. Ideal for studios, galleries or anywhere else where hidden doors may be required.



## Lateral

Specialist hinge system that allows a door to swing closed into an opening creating a flush finish. 3 sizes of kit are available ranging from small cupboard doors to large walk through applications such as walk in wardrobes.



## Duo

Top hung system for 2 or 3 door layouts. Anodised aluminium top track and nylon rollers offer smooth and quiet operation. Ideal for residential wardrobe applications and is very simple to install.



## Loft

Top hung box track bi-passing sliding door system with 4 wheel ball bearing hangers and continual bottom guidance. These factors ensure reliability and ease of operation. 2, 3 or 4 panel options are available.



## Velo

Bottom rolling bi-passing sliding door system running on bottom rails with top guidance. 2, 3 or 4 panel options. Upgraded to brass wheels for larger weight capacity and super smooth operation.

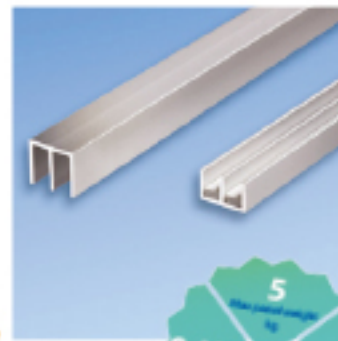

## Dura

Top and bottom tracks are precision aluminium profiles in a silver anodised finish. The bottom track contains grey nylon inserts to aid the sliding motion of the glass doors.



## Durus

Larger version of the Dura. Top and bottom tracks are precision aluminium profiles in a silver anodised finish. The bottom track contains grey nylon inserts to aid the sliding motion of the glass doors.



## Hatch Glass

Bottom rolling, bi-passing, sliding kit for a pair of glass cabinet or reception hatch doors. The tracks are anodised aluminium profiles and the concealed bottom rollers have nylon tyres and sealed ball bearings.



## Supra

High Quality glass sliding system for display cabinets or reception hatches. System can double its capacity from 25kg to 50kg by adding more bottom rollers in the rail allowing for maximum flexibility.



## Robustus

Big brother of the Supra, the Robustus can cope with an impressive 140kg making it suitable for large glass display cabinets. Capacity can be reduced to 70kg with less bottom rollers in the bottom rail for smaller applications.



# Bottom Rolling Systems



## Patioslide 100/200

Patioslide is the pinnacle of sliding door quality and comes as a complete kit. This includes tracks, rollers, guides, interlocks, handles and a PAS24 rated multipoint lock. Its effortless operation and minimum track sizes make Patioslide the No.1 choice for quality installations without the complications of lift & slide systems.

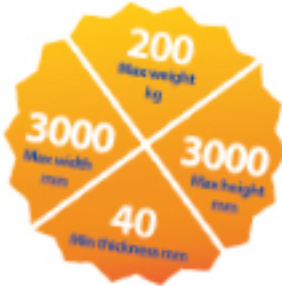

## Vistaslide 120/250/400

Vistaslide is a bottom rolling sliding door system that's simple to install and suitable for both timber and aluminium framed doors. It comes in 3 sizes, with tracks available in either aluminium or brass and includes rattle proof top guides. The Vistaslide system suits a wide range of applications and is particularly popular for car showrooms and larger commercial projects due to its durability and ease of use.



## Also available from Barrier Components



### Folding Door Hardware

Folding Door Hardware is now widely used throughout buildings in many ways. Whether its on a small cupboard or wardrobe, dividing meeting rooms in hotels, lounges and conservatories in homes and, more popular than ever, the folding patio doors that adorn more and more properties, folding door hardware is the buzz word in chic design and creating flexible space for multi use rooms.

We can offer systems for timber, aluminium or frameless glass so every option is catered for.



### Sliding & Folding Gate Hardware

We can offer an unbeatable range of sliding, telescopic, folding & cantilever gate hardware to suit every application - whether residential, commercial or industrial.

FAC are a very high quality, Italian company renowned for its forward thinking approach to gate hardware design always pushing ahead with development of their products.

We also offer a huge range of high quality Gate Locks and Hinges.



### Industrial Sliding & Folding Door Hardware

Helaform are a high quality sliding and folding door hardware manufacturer based in Finland. Barrier Components offer from stock their ever popular K series for industrial and Agricultural systems. These are widely used in all industries worldwide with applications including large aircraft hanger and barn doors, heavy duty security gates, curtain systems, conveyor, cable and watering systems and more.

Should you find anything in their catalogue that is not listed on our website as a stock item please contact us with details of your requirements.



# Top Hung Door Systems



## Barrierslide 50

Cost effective box section sliding door kit ideal for residential applications. Kit comes complete with 2m track, hangers, track stops and floor guide. Hangers have a low headroom design so the gap from door to track is minimal.

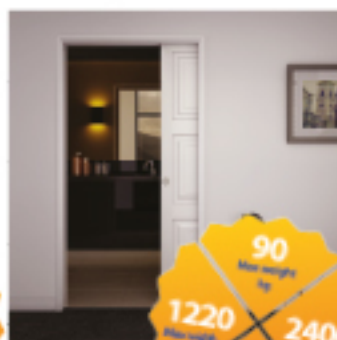

## Pocket Door Kit

Our pocket door kit allows a sliding door to hide within a wall (built with 4" stud work) when open therefore saving space. Available in 2 sizes. A glass door kit is also available. Further options include soft-close and a touch latch so the door sits flush in frame when open.



## Helaslide 100

A Helaform sliding door system that can allow for options including low headroom hangers, side fix hangers for MDF, soft-open, soft-close and synchro opening of bi-parting doors. Anodised tracks and super smooth hangers ensure a superior quality operation.



## Barrierslide Strap

A flat track system in the style of an old barn door. Available in both Stainless 304 or Matt Black finishes. Comes complete with all required fixings for installation. Soft-close and soft-open devices at both ends of the track to be removed for doors more than 80kg.



## Barrierslide Ivan 2.0

A flat track system with rollers fixed on the top of the door. Available in both Stainless 304 or Matt Black finishes. Comes complete with all required fixings for fitting. Soft-close and soft-open devices at both ends of the track to be removed for doors more than 80kg.



## Helaslide 150

This Helaform system is for high quality interior and exterior applications. Options include soft-open, soft-close and an ingenious synchro system for bi-parting doors that's all mounted and concealed within the top track. Hanger bodies and plates are all 316L Stainless.



## Barrierslide 300/400

Our heavier duty top hung commercial & residential sliding door systems are ideal for both internal and external installations. Due to the weights involved the structure must be able to support these weights effectively. Both systems are silky smooth to operate.

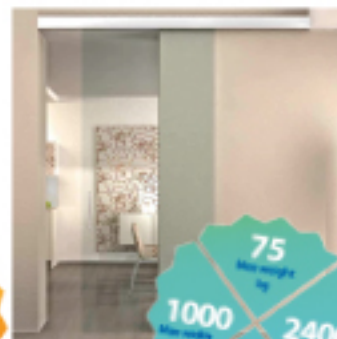

## Slak

Simple, cost effective and requiring no glass drilling. The Slak has a very clean and minimal look and is a great budget conscious choice for sliding glass door applications. Glass clamps are hidden when the pelmet is attached to the track.



## Barrierslide Crystal

A high quality sliding door system for glass doors at a very competitive price. Made from 304 Stainless, this system incorporates a tubular track with built in soft-open and soft-close devices which also double up as an anti lift feature.



## G-Tech

Our ever popular contemporary glass door sliding system. Precision made from 304 Stainless steel combined with a silky smooth operation make this a perfect solution for both commercial and residential applications.



## SDT

A glass sliding system with multiple options fixing to a glass door. Standard square or elegant rounded fittings can be used. Alternatively a solid door rail is also available. SDT Can also be used as a sliding shower system.

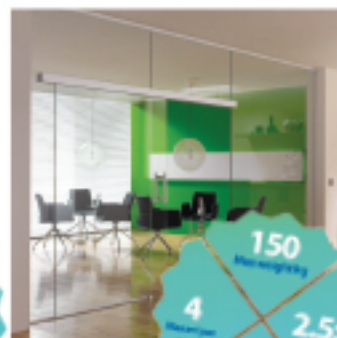

## Portavant

The standard to which all systems aspire to. Portavant has systems available for glass doors up to 150kg in weight and has capacity to be used for telescopic door systems. With soft-close and soft-open available and a stunning quality finish.

# Sliding Door Accessories

We have a range of accessories for sliding doors to suit both timber and glass doors. They include handles, seals, door closers and soft close systems to complement the range. We are constantly updating our range, so please visit our website which always features our very latest innovations.



## Sliding Door Closer

Can be retro fitted to any smooth running door system for a door up to 100kg and 1220mm wide. Speed adjustable and near silent in operation. Silver anodised finish.



## Softclose 50

Can be retro fitted to an existing door as long as there is adequate clearance between track and top of door. Sliding track must be very smooth with minimal resistance and doors must weigh no more than 50kg.



## Pocket Touch Latch

Inserts into the back of a door before placing into pocket situation. Latch then allows door to close flush with the frame when open and then to pop forward with a gentle press on the doors edge.



## 504 Flush Pulls

Available in satin stainless or PVD gold finishes.

120mm high x 41mm wide. 12mm deep



## 503 Flush Pulls

Silver anodised or gold anodised finishes.

112mm high x 42mm wide, 15mm deep

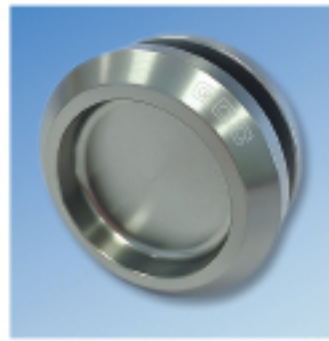

## GCC Flush Pulls

Pair of satin nickel finished flush pulls ideal for both glass and timber doors. High strength adhesive secures them in place therefore no drilling is required and there are no visible fixings.



## Sliding Latch Set

Available in both satin and polished chrome finishes. Also comes complete with edge fix finger pull.

Choice of 1 snib, 1 coin release or 2 snib layouts.



## 6 Point Sliding Lock

6 point inline sliding door lock suitable for euro cylinder (sold separately). Perfect for sliding patio door. Has achieved Secure By Design when tested as part of a complete system.

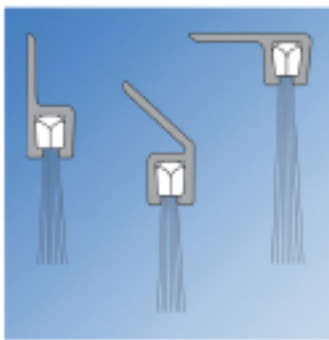

## F, H & Y Brush Seals

High quality brush strip housed in an aluminium retainer. sold in 3000mm lengths with various brush sizes available. F & H aluminium profiles are both well suited to sliding doors but a Y profile is also available.

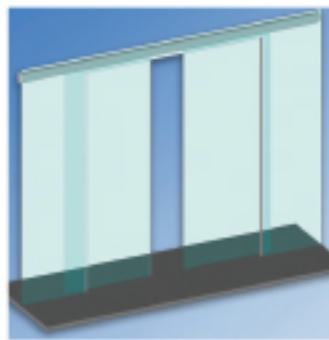

## Adhesive Seals

High quality, self adhesive weatherstrips for glass offer major aesthetic advantages as well as an ideal way to retro fit seals to any existing frameless glass doors. Range includes a drop down weatherseal and an adjustable shower seal.

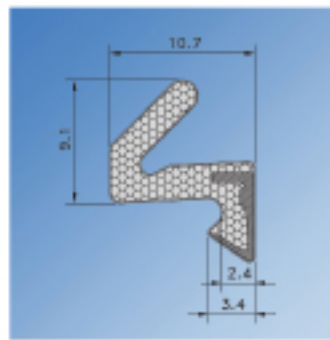

## AQ21 Weatherseal

No seal is as popular as the AQ21 the industry standard when it comes to external door weather protection. Strong, easy to use and tough, the AQ21 seal works with swing, sliding and folding timber framed doors. Black finish.

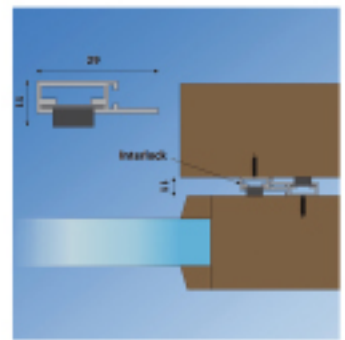

## Sliding Door Interlock

Specifically designed for patio doors so that when closed the door is held firm to the fixed panels leading edge. This ensures a more secure and weatherproof installation. Totally concealed when doors are closed.



# Sliding Door Product Selector

Quick reference guide based on weight and preference of top hung or bottom rolling door systems.

Cupboard & Wardrobe			Top Hung Door System			Bottom Rolling Door System	
System	KG		System	KG	Softclose KG	System	KG
Linear	15	-	Barrierslide 50	50	50	Patioslide 100	100
Hatch T	20	B	Pocket Door Kit	50	90	Vistaslide 120	120
Flush	30	T	Helaslide 100	100	100	Patioslide 200	200
Lateral	35	T	Barrierslide Strap	80	150	Vistaslide 250	250
Duo	45	T	Barrierslide Ivan 2.0	80	150	Vistaslide 400	400
Loft	100	T	Helaslide 150	150	150		
Velo	120	B	Barrierslide 300		300		
Dura	5	-	Barrierslide 400		400		
Durus	5	-	Slak		75		
Hatch Glass	20	B	Barrierslide Crystal	80	80		
Supra	25	B	G-Tech		100		
	50	B	SDT		100		
Robustus	70	B	Portavant	80	150		
	140	B					

T (Top Hung)  
B (Bottom Rolling)

### Door Controls

System	KG
Sliding Door Closer	100
Softclose 50	50

Barrier Components Ltd, established in 1987, is now one of the leading UK stockists of quality architectural hardware, supplying products to both commercial and residential markets. We provide a one-stop shop for weather seals, brush strips, glass hardware, sliding door hardware, gate hardware, shower hardware, swing doors and much more. Check out our website to download a selection of product brochures from the Barrier Components range.



**Barrier Components Ltd**  
 Unit 8 Dolphin Way Dolphyn Point Purfleet  
 Essex RM19 1NR  
 t: 01708 891 515 f: 01708 891 516  
 sales@barrier-components.co.uk  
 www.barrier-components.co.uk

